

ADH Technology Co. Ltd.

ADH8012 GSM GPRS Modem User's Manual

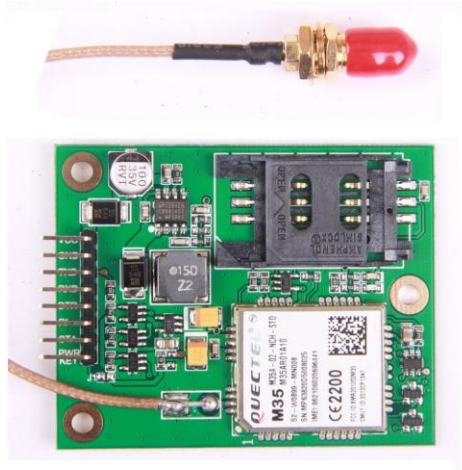

www.adh-tech.com.tw
sales@adh-tech.com.tw

ADH8012 GSM GPRS Modem User's Manual

Content

ADH8012 GSM GPRS Modem User's Manual	1
1. Introduction	3
2. Product concept	3
3. Application interface	5
3.1 Pin Description	5
3.2 Operating modes.....	6
3.3 Power up and power down scenarios	7
3.3.1 Power On	7
3.3.2 Power on automatically	8
3.3.3 Power down module using the PWRKEY pin.....	8
3.3.4 Power down module using AT command	9
3.3.5 Restart module using the PWRKEY pin	9
3.4 Power saving	10
3.4.1 Minimum functionality mode.....	10
3.4.2 SLEEP mode (slow clock mode).....	11
3.4.3 Wake up module from SLEEP mode	11
3.5 Summary of state transitions	11
3.6 Serial interfaces	12
3.7 LED indication	12
3.7.1 Red Led is the power indication.....	12
3.7.2 Green Led is the Working state indication.	12
4. Mechanical dimension.....	13
5. Product List	14

ADH8012 GSM GPRS Modem User's Manual

1. Introduction

This document defines the ADH8012 module series and describes the hardware interface of the ADH8012 module that connects to the customer application.

This document can help customer quickly understand module interface specifications, electrical and mechanical details. With the help of this document, associated application notes and user guide, customer can use ADH8012 module to design and set up mobile applications quickly.

2. Product concept

The ADH8012 is a Quad-band GSM/GPRS engine that works at frequencies GSM850MHz, GSM900MHz, DCS1800MHz and PCS1900MHz. The ADH8012 features GPRS multi-slot class 12 and supports the GPRS coding schemes CS-1, CS-2, CS-3 and CS-4.

The ADH8012 is integrated with Internet service protocols, which are TCP/UDP, FTP and HTTP.

Extended AT commands have been developed for customer to use these Internet service protocols easily.

Table 1 Module key features

Feature	Implementation
Power supply	Single supply voltage 6.0V – 24.0V (5.0V Customize)
Frequency bands	<ul style="list-style-type: none">• Quad-band: GSM850, GSM900, DCS1800, PCS1900.• The module can search these frequency bands automatically• The frequency bands can be set by AT command.• Compliant to GSM Phase 2/2+
Transmitting power	<ul style="list-style-type: none">• Class 4 (2W) at GSM850 and GSM900• Class 1 (1W) at DCS1800 and PCS1900
GPRS connectivity	<ul style="list-style-type: none">• GPRS multi-slot class 12 (default)• GPRS multi-slot class 1~12 (configurable)• GPRS mobile station class B
Temperature range	<ul style="list-style-type: none">• Normal operation: -35°C ~ +80°C• Restricted operation: -45°C ~ -35°C and +80°C ~ +85°C ¹⁾• Storage temperature: -45°C ~ +90°C
DATA GPRS:	<ul style="list-style-type: none">• GPRS data downlink transfer: max. 85.6 kbps• GPRS data uplink transfer: max. 85.6 kbps• Coding scheme: CS-1, CS-2, CS-3 and CS-4• Support the protocols PAP (Password Authentication Protocol)

ADH8012 GSM GPRS Modem User's Manual

CSD:	usually used for PPP connections <ul style="list-style-type: none"> ● Internet service protocols TCP/UDP/FTP/HTTP ● Support Packet Switched Broadcast Control Channel (PBCCH) ● CSD transmission rates: 2.4, 4.8, 9.6, 14.4 kbps non-transparent ● Unstructured Supplementary Services Data (USSD) support
SMS	<ul style="list-style-type: none"> ● MT, MO, CB, Text and PDU mode ● SMS storage: SIM card
FAX	Group 3 Class 1 and Class 2
SIM interface	Port SIM card: 1.8V, 3V, Protected against ESD with a TVS diode array.
Serial interface	<ul style="list-style-type: none"> ● Support from 4800 bps to 115200 bps, default auto baud rate ● UART default 3.3V TTL level, optional 5V TTL level ● Embed standard AT command (GSM07.05 and 07.07)
Phonebookmanagement	Support phonebook types: SM, FD, LD, RC, ON, MC
SIM Application Toolkit	Support SAT class 3, GSM 11.14 Release 99
Physical characteristics	58*46*12mm

1) When the module works in this temperature range, the deviations from the GSM specification might occur. For example, the frequency error or the phase error could increase.

Table 2 Coding schemes and maximum net data rates over air interface

Coding scheme	1 Timeslot	2 Timeslot	4 Timeslot
CS-1:	9.05kbps	18.1kbps	36.2kbps
CS-2:	13.4kbps	26.8kbps	53.6kbps
CS-3:	15.6kbps	31.2kbps	62.4kbps
CS-4:	21.4kbps	42.8kbps	85.6kbps

3. Application interface

3.1 Pin Description

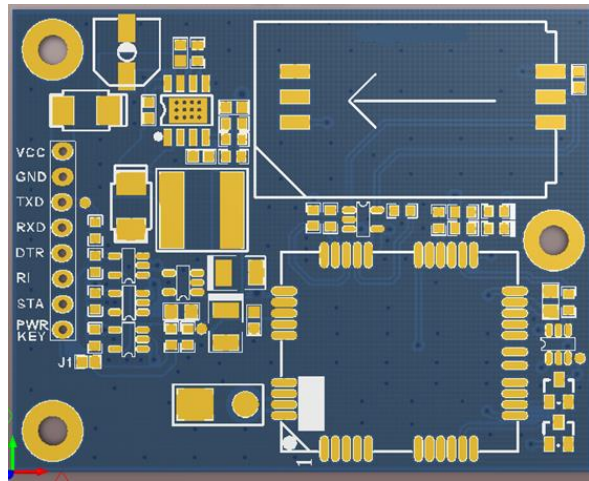

Figure 1 Pin distribution

Table 3 Pin description

PIN NAME	PIN	I/O	DESCRIPTION	DC CHARATERISTICS	COMMENT
VCC	1	P	Power	6.0V – 24.0V (5.0V Customize)	
GND	2	P	Power and signal ground		
TXD	3	O	TTL level: UART Transmitting data.	Default 3.3V TTL	5.0V TTL Optional
RXD	4	I	TTL level:	3.3V and 5.0V TTL Compatible	

ADH8012 GSM GPRS Modem User's Manual

			UART Receiving data.		
DTR	5	I	TTL level: Data terminal ready	3.3V and 5.0V TTL Compatible	
RI	6	O	TTL level: Ring indicator	Default 3.3V TTL	5.0V TTL Optional
STA	7	O	TTL level: Used to indicate the module operating status. High level indicates module powered on and low level indicates powered off.	Default 3.3V TTL	5.0V TTL Optional
PWRKEY	8	I	TTL level: Power on/off control input, PWRKEY should be pulled up for a moment to turn on or turn off the module.	3.3V and 5.0V TTL Compatible	

3.2 Operating modes

The table below briefly summarizes the various operating modes referred to in the following chapters.

Table 4 Overview of operating modes

Mode	Function	
Normal operation	GSM/GPRS SLEEP	The module will automatically go into SLEEP mode if DTR is set to high level and there is no interrupt (such as GPIO interrupt or data on serial port). In this case, the current consumption of module will reduce to the minimal level. During SLEEP mode, the module can still receive paging message and SMS from the system normally.
	GSM IDLE	Software is active. The module has registered to the GSM network, and the module is ready to send and receive.
	GSM TALK	GSM connection is going. In this mode, the power consumption is decided by the configuration of Power

ADH8012 GSM GPRS Modem User's Manual

		Control Level (PCL), dynamic DTX control and the working RF band.
	GPRS IDLE	The module is not registered to GPRS network. The module is not reachable through GPRS channel.
	GPRS STANDBY	The module is registered to GPRS network, but no GPRS PDP context is active. The SGSN knows the Routing Area where the module is located at.
	GPRS READY	The PDP context is active, but no data transfer is going on. The module is ready to receive or send GPRS data. The SGSN knows the cell where the module is located at.
	GPRS DATA	There is GPRS data in transfer. In this mode, power consumption is decided by the PCL, working RF band and GPRS multi-slot configuration.
POWER DOWN	Normal shutdown by sending the “AT+QPOWD=1” command, using the PWRKEY pin. The power management ASIC disconnects the power supply from the base band part of the module, and only the power supply for the RTC is remained. Software is not active. The serial interfaces are not accessible. Operating voltage (connected to VBAT) remains applied.	
Minimum functionality mode (without removing power supply)	Use the “AT+CFUN” command can set the module to a minimum functionality mode without removing the power supply. In this case, the RF part of the module will not work or the SIM card will not be accessible, or both RF part and SIM card will be closed all, but the serial port is still accessible. The power consumption in this case is very low.	

3.3 Power up and power down scenarios

3.3.1 Power On

Customer's application can turn on the module by driving the pin PWRKEY to a high level voltage and after STATUS pin outputs a high level, PWRKEY pin can be released. Customer may monitor the level of the STATUS pin to judge whether the module is power-on or not. If the STATUS pin is ignored, pull the PWRKEY pin to high level for more than 2 seconds to turn on the module. The power on timing is illustrated as following figure2.

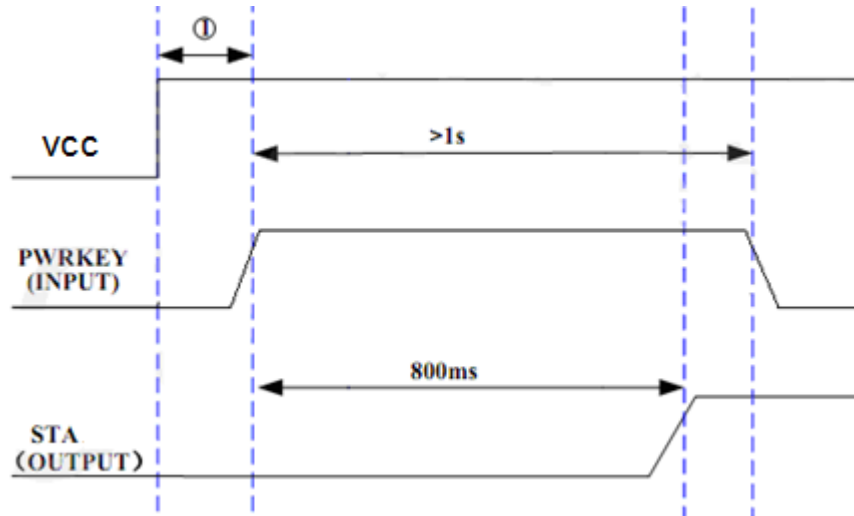

Figure 2 Timing of turn on the module

Note: The module is set to auto baud rate mode (AT+IPR=0) in default configuration. In the auto baud rate mode, the URC “RDY” after powering on is not sent to host controller. AT command can be sent to the module 2-3 seconds after the module is powered on. Host controller should firstly send an “AT” or “at” string in order that the module can detect baud rate of host controller, and it should send the second or the third “AT” or “at” string until receiving “OK” string from module. If you need to using fixed baud rate, Then an “AT+IPR=x;&W” should be sent to module and save the configuration to flash memory of module. After these configurations, the URC “RDY” would be received from the Serial Port of module every time when the module is powered on. Refer to Chapter “AT+IPR” in AR command manual.

3.3.2 Power on automatically

If user application just connects the UART signal RXD and TXD with module, user can short circuit the “J1” jumper. The “J1” jumper shows in figure 3.



Figure 3 J1 jumper

3.3.3 Power down module using the PWRKEY pin

Customer's application can turn off the module by driving the PWRKEY to a high level voltage for certain time. The power-down scenario is illustrated as in Figure 4.

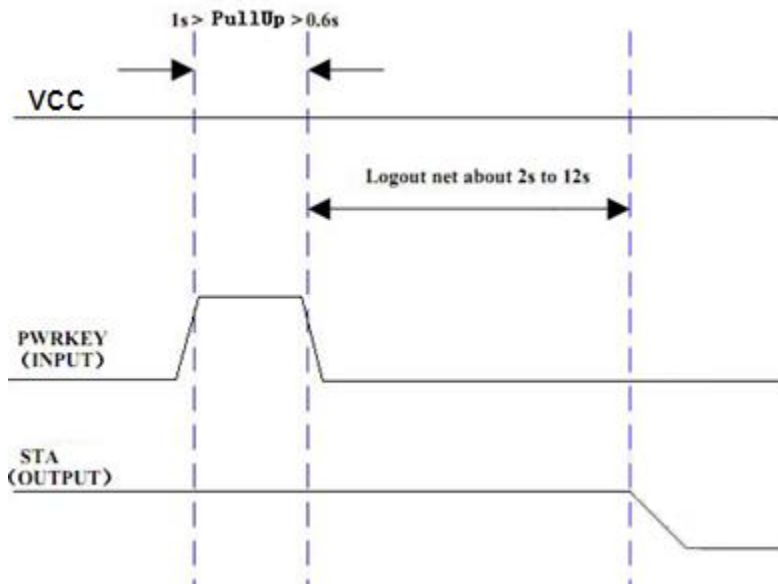

Figure 4 Timing of turn off the module

The power-down procedure causes the module to log off from the network and allows the software to save important data before completely disconnecting the power supply, thus it is a safe way. Before the completion of the power-down procedure the module sends out the result code shown below:

NORMAL POWER DOWN

After this moment, no further AT command can be executed, and then the module enters the POWER DOWN mode, The POWER DOWN mode can also be indicated by STATUS pin, which is a low level voltage in this mode.

3.3.4 Power down module using AT command

Customer's application can use an AT command "AT+QPOWD=1" to turn off the module. This command will let the module to log off from the network and allow the software to save important data before completely disconnecting the power supply, thus it is a safe way.

Before the completion of the power-down procedure the module sends out the result code shown below:

NORMAL POWER DOWN

After this moment, no further AT command can be executed, and then the module enters the POWER DOWN mode, The POWER DOWN mode can also be indicated by STATUS pin, which is a low level voltage in this mode.

3.3.5 Restart module using the PWRKEY pin

Customer's application can restart the module by driving the PWRKEY to a high level voltage for certain time, which is similar to the way to turn on module. Before restarting the module, at least

500ms should be delayed after detecting the low level of STATUS. The restart scenario is illustrated as the following figure 5.

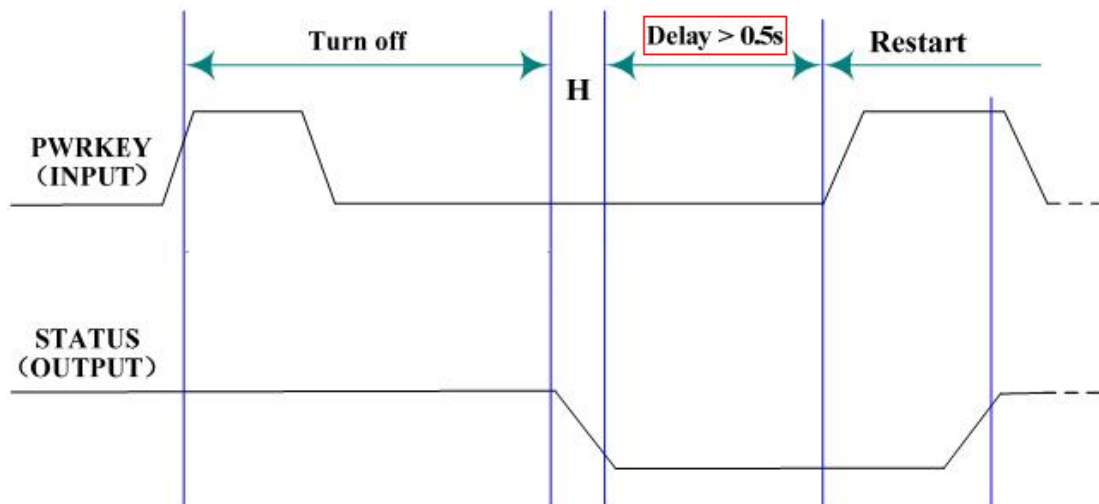

Figure 5 Timing of restart system

3.4 Power saving

Upon system requirement, there are several actions to drive the module to enter low current consumption status. For example, “AT+CFUN” can be used to set module into minimum functionality mode and DTR hardware interface signal can be used to lead system to SLEEP mode.

3.4.1 Minimum functionality mode

Minimum functionality mode reduces the functionality of the module to minimum level, thus minimizes the current consumption when the slow clocking mode is activated at the same time.

This mode is set with the “AT+CFUN” command which provides the choice of the functionality levels <fun>=0,1,4.

- 0: Minimum functionality;
- 1: Full functionality (default);
- 4: Disable both transmitting and receiving of RF part;

If the module is set to minimum functionality by “AT+CFUN=0”, the RF function and SIM card function would be closed. In this case, the serial port is still accessible, but all AT commands correlative with RF function or SIM card function will not be accessible.

If the module has been set by “AT+CFUN=4”, the RF function will be closed, the serial port is still active. In this case, all AT commands correlative with RF function will not be accessible.

After the module is set by “AT+CFUN=0” or “AT+CFUN=4”, it can return to full functionality by “AT+CFUN=1”.

For detailed information about “AT+CFUN”, please refer to AT command manual.

ADH8012 GSM GPRS Modem User's Manual

3.4.2 SLEEP mode (slow clock mode)

The SLEEP mode is disabled in default software configuration. Customer's application can enable this mode by "AT+QSCLK=1". On the other hand, the default setting is "AT+QSCLK=0" and in this mode, the module can't enter SLEEP mode.

When "AT+QSCLK=1" is set to the module, customer's application can control the module to enter or exit from the SLEEP mode through pin DTR. When DTR is set to high level, and there is no on-air or hardware interrupt such as GPIO interrupt or data on serial port, the module will enter SLEEP mode automatically. In this mode, the module can still receive voice, SMS or GPRS paging from network but the serial port is not accessible.

3.4.3 Wake up module from SLEEP mode

When the module is in the SLEEP mode, the following methods can wake up the module.

- If the DTR Pin is pulled down to a low level, it would wake up the module from the SLEEP mode. The serial port will be active about 20ms after DTR changed to low level.
- Receiving a voice or data call from network to wake up module.
- Receiving an SMS from network to wake up module.

Note: DTR pin should be held low level during communicating between the module and Customer's application.

3.5 Summary of state transitions

Table 5 Summary of state transition

Current mode	Next mode		
	Power Down	Normal Mode	Sleep Mode
Power Down		Use PWRKEY pin	
Normal mode	AT+QPOWD or use PWRKEY pin,		Set AT+QSCLK=1 and pull up the DTR pin to high level
Sleep Mode	Use PWRKEY pin	Pull down DTR pin to low level, Receiving a voice or data call from network, Receiving an SMS from network	

3.6 Serial interfaces

The connection schematic between ADH8012 and MCU/ARM shown in figure 6, Dotted line: optional connection (If unconnected PWRKEY, need to short circuit "J1" jumper).

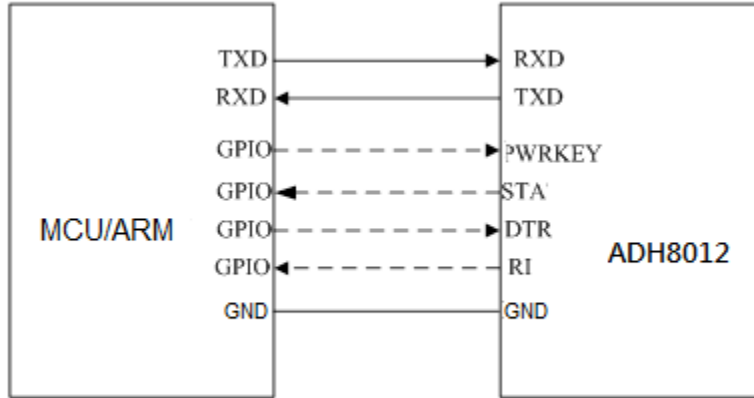

Figure 6 connect to MCU/ARM

3.7 LED indication

3.7.1 Red Led is the power indication.

3.7.2 Green Led is the Working state indication.

The Working state of this LED is list in the table 6.

Table 6 Working state indication

state	Module Function
Off	The module is not running(Power Off)
64ms On/800ms Off	The module is not synchronized with network
64ms On/2000ms Off	The module is synchronized with network
64ms On/600ms Off	GPRS data transfer is ongoing.

4. Mechanical dimension

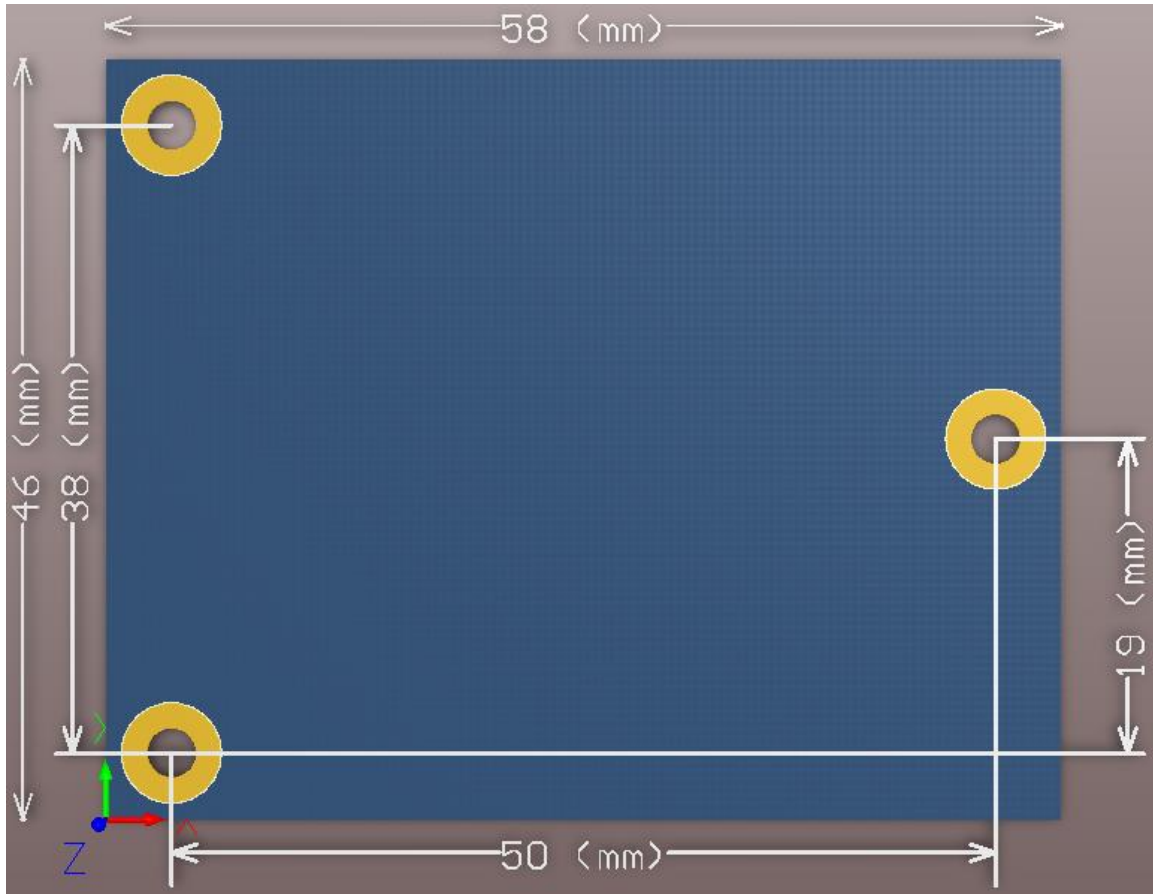

5. Product List

Name	Unit	Quantity	Describe	Picture
ADH8012	Item	1	Module	
Antenna	Item	1	Standard Supply	